



Version  
04.00  
December  
2003

## Microwave Signal Generator R&S®SMP

Excellent signal characteristics through to 40 GHz

- ◆ Instrument family with four models
  - R&S®SMP02 (10 MHz to 20 GHz)
  - R&S®SMP22 (10 MHz to 20 GHz)
  - R&S®SMP03 (10 MHz to 27 GHz)
  - R&S®SMP04 (10 MHz to 40 GHz)
- ◆ High output level
  - R&S®SMP02 >+11.5 dBm
  - R&S®SMP22 >+20 dBm (typ. +29 dBm at 2 GHz)
  - R&S®SMP03 >+13 dBm
  - R&S®SMP04 >+10 dBm
- ◆ Optional pulse modulator and pulse generator
- ◆ Digital RF, AF and level sweep
- ◆ Storage of 50 complete instrument setups
- ◆ Optional phase modulator
- ◆ ASK/FSK modulation, phase offset settings
- ◆ Extremely low SSB phase noise at 10 GHz (<-105 dBc (1 Hz) at 10 kHz from carrier)
- ◆ Very short frequency setting time <11 ms + 5 ms/GHz
- ◆ Extremely high level accuracy <±0.9 dB at 0 dBm in frequency range 10 MHz to 40 GHz



**ROHDE & SCHWARZ**

## Microwave signals in the range from 10 MHz to 40 GHz

The basic models of the R&S®SMP cover the following frequency ranges:

- ◆ R&S®SMP02/R&S®SMP 22 (2 GHz to 20 GHz)
- ◆ R&S®SMP03 (2 GHz to 27 GHz)
- ◆ R&S®SMP04 (2 GHz to 40 GHz)

The lower frequency limit can be optionally extended to 10 MHz.

A modern frequency synthesis concept with direct digital synthesis (DDS) ensures the following:

- ◆ Stable output frequency
- ◆ 0.1 Hz frequency resolution
- ◆ Fast settling after a frequency change

## High, levelled output power

All R&S®SMP models have been designed for high output power without any compromises:

- ◆ R&S®SMP02 (>+11.5 dBm)
- ◆ R&S®SMP22 (>+20 dBm)
- ◆ R&S®SMP03 (>+13 dBm)
- ◆ R&S®SMP04 (>+10 dBm)

The output levels specified are valid for the upper frequency limit.

## Excellent spectral purity

High spectral purity is ensured by the use of YIG oscillators – up to 20 GHz without any frequency multiplying:

- ◆ Harmonics  
typ. <-50 dBc for  $f > 1.8$  GHz
- ◆ Nonharmonics <-60/54 dBc  
up to/above 20 GHz
- ◆ SSB phase noise at  
10 GHz <-105 dBc (1 Hz)  
(10 kHz from carrier)

## Versatile modulation capabilities

AM, FM and optional  $\phi$ M modulation meet the high standards usually expected of low-frequency generators only. The large variety of options includes a high-speed pulse modulator:

- ◆ AM (DC to 100 kHz)
- ◆ FM (DC to 5 MHz)
- ◆  $\phi$ M (DC to 100 kHz)
- ◆ Pulse modulation with  
on/off ratio >80 dB

## Large choice of options for user-specific configuration

A wide selection of options allows the R&S®SMP to be configured economically to meet today's and tomorrow's requirements:

- ◆ Pulse generator and pulse modulators
- ◆ Frequency extension 0.01 GHz to 2 GHz
- ◆ RF attenuator
- ◆ Modulation generator up to 500 kHz
- ◆ Precision FM/ $\phi$ M modulator
- ◆ OCXO reference oscillator
- ◆ Auxiliary interface

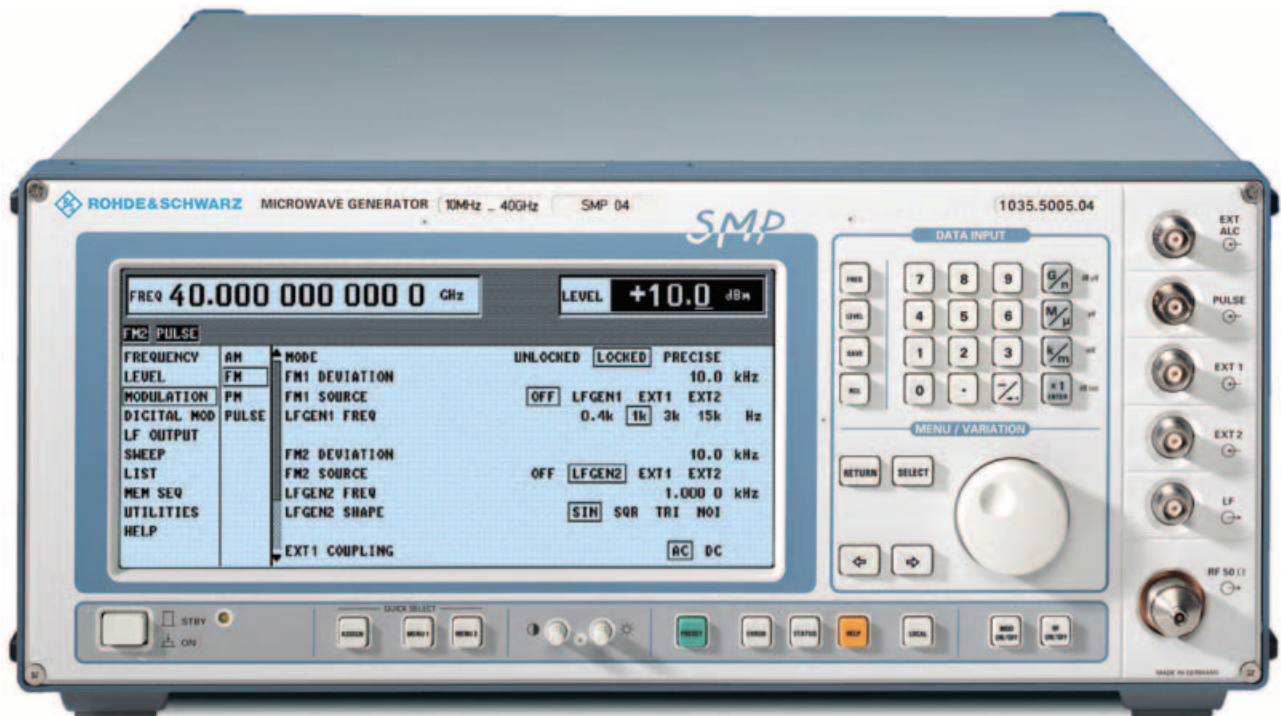

## Intelligent menu guidance for maximum ease of operation

- ◆ Large-size LC display
- ◆ Menu-guided operation with all menu levels being shown at a glance
- ◆ Two menu memories to speed up operation

## User-friendly details

- ◆ Digital RF, AF and level sweep
- ◆ Storage of 50 complete instrument setups
- ◆ Combination of any modulation modes possible
- ◆ Ultra-low RF leakage
- ◆ RF control output

## Unambiguous results due to high spectral purity

The outstanding features of the R&S®SMP are the extremely low SSB phase noise of  $<-105$  dBc (1 Hz) at 10 GHz (10 kHz from carrier) as well as nonharmonics of  $<-60/54$  dBc up to/above 20 GHz. The high harmonics rejection and the complete absence of subharmonics below 20 GHz cut out time-wasting measurements such as occur with inferior signal generators.

## Minimum level error

A highly precise level is required, for example, for measurements and calibration of receivers. A controlled and frequency-response-compensated output level is a basic prerequisite for setting accuracy. In conjunction with a precision attenuator (option R&S®SMP-B15/-B17), an extremely high level accuracy is ensured throughout the setting range ( $\leq \pm 0.9$  dB at 0 dBm in the frequency range 10 MHz to 40 GHz).

## Stable output frequency

The crystal reference built-in as standard ensures an accurate and low-drift output frequency.

The R&S®SMP can also be fitted with an oven-controlled crystal oscillator (option R&S®SMP-B1, OCXO) to meet the most exacting requirements.

## High output level eliminates the need for add-on units

A large number of microwave measurements requires mainly one thing: a high output level, which until now has only been possible with expensive add-on amplifiers.

Owing to their high output levels, the R&S®SMP models feature sufficient reserves for compensating the attenuation of long cables as well as the losses of power splitters and directional couplers.

The R&S®SMP22 achieves a level of up to 29 dBm at 2 GHz and an excellent value of 23 dBm at 20 GHz.

## Our standard: 0.1 Hz frequency resolution

A high frequency resolution is required especially for scientific applications and in industrial research, e.g. for surface measurements of materials using radar equipment.

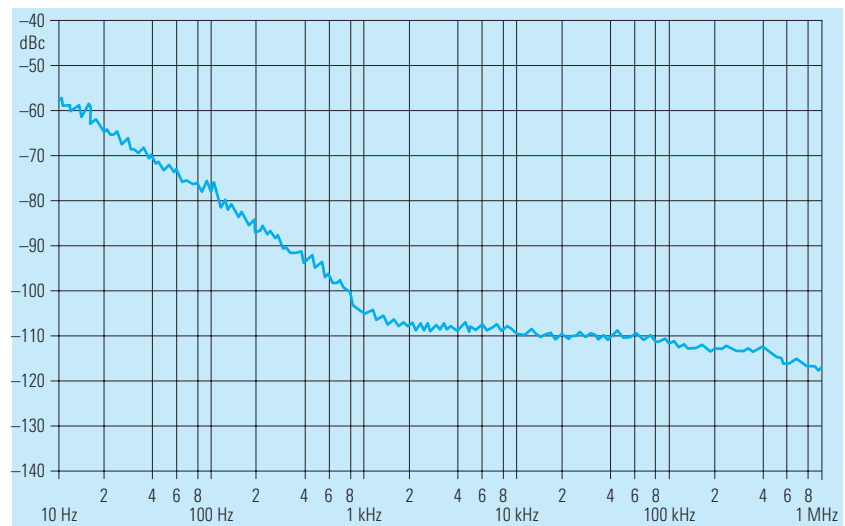

FIG 1: SSB phase noise at 10 GHz

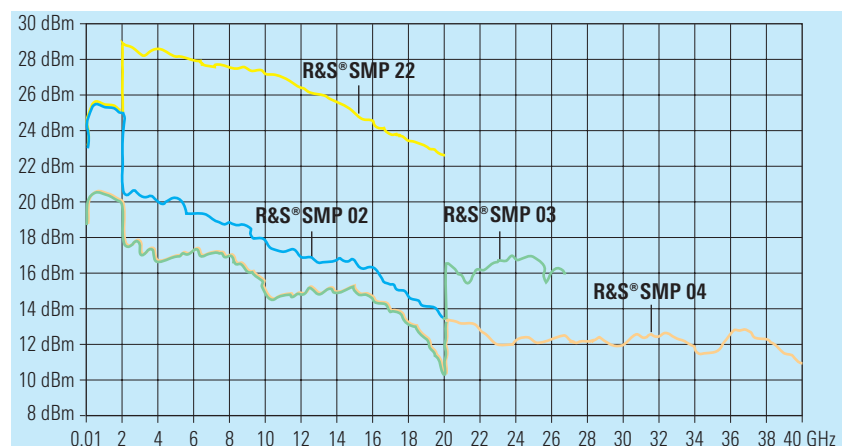

FIG 2: Typical maximum level versus frequency

The R&S®SMP is setting standards with a resolution of 0.1 Hz throughout its frequency range, and even above 20 GHz.

## Variety of applications

The R&S®SMP is ideal for the following applications:

- ◆ Substitution of local oscillators
- ◆ Measurements on nonlinear components such as frequency multipliers or high-level mixers
- ◆ Driving of travelling wave tubes (TWTs) and other power stages
- ◆ Interconnection of several signal generators for intermodulation measurements
- ◆ Tracking generator for spectrum and network analyzers

## High-quality shielding

Sensitivity measurements on low-noise satellite receivers can only be made with absolutely RF-leakage-proof signal sources.

The comprehensive shielding of the R&S®SMP ensures extremely low RF leakage.

## Frequency and phase modulation

The R&S®SMP is fitted as standard with a broadband FM modulator covering a modulation frequency range up to 5 MHz for deviations up to 10 MHz (20 MHz above 20 GHz).

In addition, a precision FM/φM modulator (option R&S®SM-B5) with a modulation frequency range of up to 1 MHz and maximum deviation of up to 1 MHz (2 MHz for  $f > 20$  GHz) is available for testing communication receivers and for scientific applications.

## FSK modulation

Owing to a special frequency control circuit, the precision FM/φM modulator features an extremely high carrier frequency accuracy and stability in the FM DC mode. Digital frequency shift keying (FSK modulation) is also possible. A deviation of up to 1 MHz (2 MHz above 20 GHz) can be selected.

## Wide φM modulation range

The wide frequency range of the phase modulation extending from DC to 100 kHz allows testing of phase-sensitive circuits.

## R&S®SMP for use as a VCO

In DC-coupled FM or φM mode, the R&S®SMP can also be used as a voltage-controlled oscillator (VCO) and integrated into an external frequency control loop. The RF control output fitted on the rear panel is very useful for this application.

The RF control output provides signals in the frequency range 2 GHz to 20 GHz and can, for example, be used for monitoring the output frequency with the aid of a frequency counter (FIG 3).

## Pulse modulation

### Ideal for radar receivers

All data specified for pulse modulation, which is frequently used in the development, production and maintenance of radar receivers, is valid throughout the rated frequency range and also at the important intermediate frequencies of 70 MHz and 140 MHz. The on/off ratio is better than 80 dB, the rise/fall time shorter than 10 ns. Pulse widths of less than 20 ns are possible (FIG 4).

### Optional pulse generator

In addition to feeding in external modulation signals, the pulse generator (option R&S®SMP-B14) can also be used to gen-

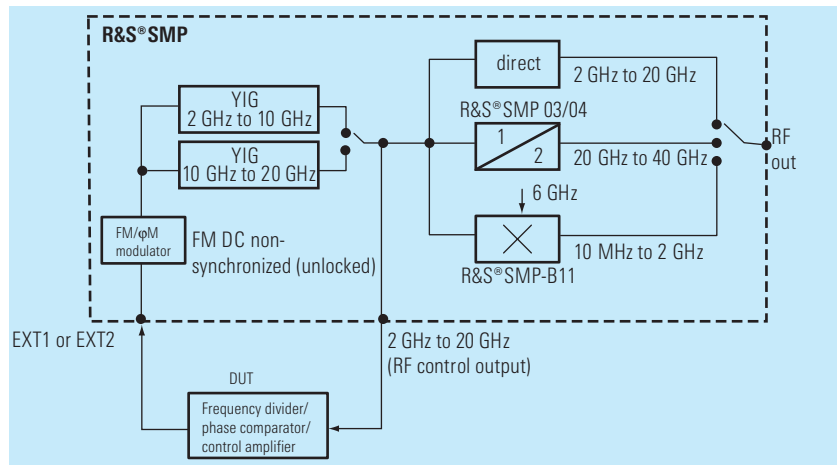

FIG 3: R&S®SMP as a VCO

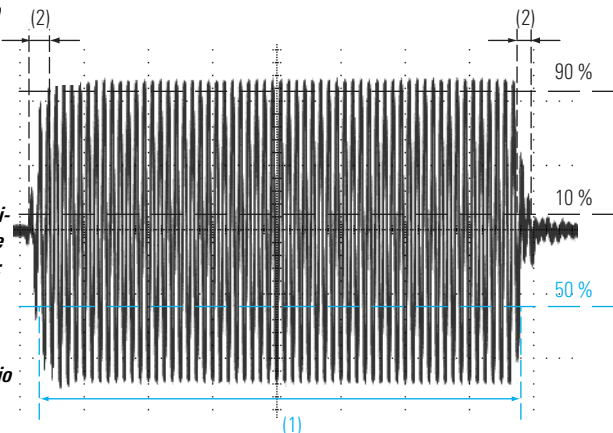

FIG 4: Pulse modulator, universally used in microwave applications such as radar; (1) shortest pulse duration 20 ns, (2) typ. 3 ns rise/fall time, more than 80 dB on/off ratio

erate internal single or double pulses with pulse frequencies up to 10 MHz.

The pulse generator can also be triggered externally, pulse width and delay being user-selectable over a wide range.

## Simultaneous modulation modes and their application

All modulation modes which the R&S®SMP is able to generate can be combined (in the case of the R&S®SMP 03/04 with some restrictions regarding pulse and amplitude modulation). Highly complex signals can thus be generated for modern communication and radar systems.

### Doppler effects

The combination of pulse modulation and FM DC simulates Doppler effects and also chirp signals.

### Pulse radar with rotating antenna

Combined scan and pulse modulation provides the type of signals occurring in pulse radar applications with rotating antenna.

In the example shown in FIG 5, the external pulse from the pulse generator or radar display is applied to the external pulse input of the R&S®SMP and used as

a trigger for the internal pulse generator and modulator.

The main advantage of this kind of trigger is that it can be delayed to simulate distance and direction and to check the values on the display.

### Fading

Simultaneous frequency and amplitude modulation can be used to study fading effects of FM receivers.

## Sweep capabilities

### Level sweep

The 20 dB level sweep of the R&S®SMP is an efficient function for determining power characteristics and for compression measurements.

### Digital frequency sweep

The digital frequency sweep with steps from 10 ms is a useful facility for measuring the frequency response of microwave modules or antennas.

### Sweep modes

The digital sweep can be executed automatically in repetitive mode or in single-shot mode with selectable sweep time. Manual sweeping (STEP MODE) within the sweep limits is also possible. Trigger

inputs and outputs facilitate synchronous operation in conjunction with other instruments.

### Use in EMC measurements

Functions qualifying the R&S®SMP for EMC applications include the trigger facility for step-by-step sweeping, marker outputs and, above all, the extension of the frequency range to 10 MHz (option R&S®SMP-B11).

The capability of compensating external frequency responses is also an important feature.

## Frequency hopping in list mode

One of the very special features of the R&S®SMP is the list mode. Unlike the normal sweep mode with increasing or decreasing frequencies, the list mode can be used for programming frequency hopping. A list editor makes programming extremely easy. Up to 2003 pairs of frequency and level values can be stored in lists.

Of course, the same types of sweep can be executed in the list mode as in the normal sweep mode.

## Frequency response compensation

Power amplifiers, cables, antennas and TEM cells usually exhibit a relatively large frequency response which has to be compensated to obtain accurate measurement results.

The R&S®SMP provides two excellent tools for the correction of external frequency responses:

- ◆ User-defined correction of external frequency responses
- ◆ External level control using a power meter

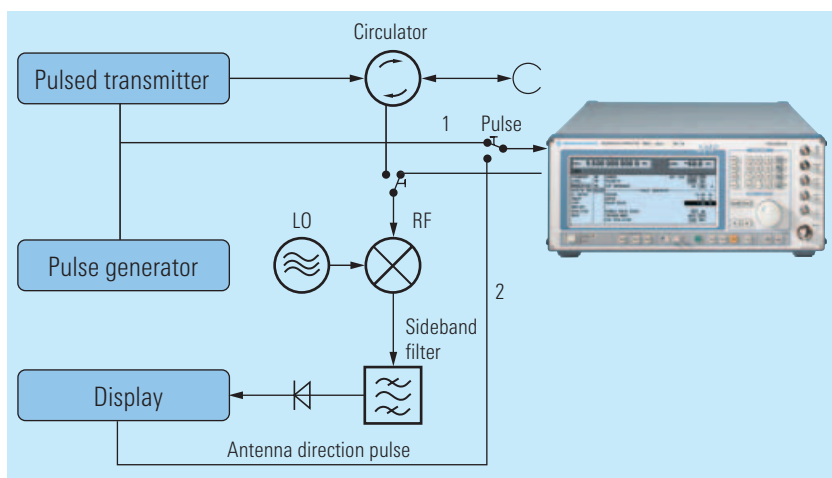

FIG 5: Radar tests (switch position 1 for testing the distance indicated by radar, switch position 2 for testing the antenna direction indicated by radar)



### User-defined correction of external frequency responses

The user correction function is extremely useful for fast RF sweeps, for example to compensate nonlinearities of an amplifier.

The known frequency response can be compensated by entering level correction values for up to 160 frequency points. The correction values for the frequencies between these points are determined by means of automatic interpolation (FIG 6).

In addition, the R&S®SMP can automatically measure the level correction values at a keystroke with the aid of external power meters such as the R&S®NRVS or R&S®NRVD.

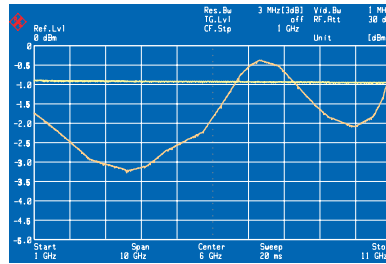
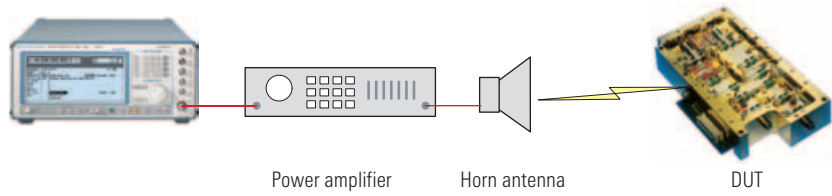

FIG 6: Output level with frequency response correction ON (yellow curve) and OFF (orange curve)

### External level control using a power meter

A very simple method is the external level control with high level accuracy (FIG 7).

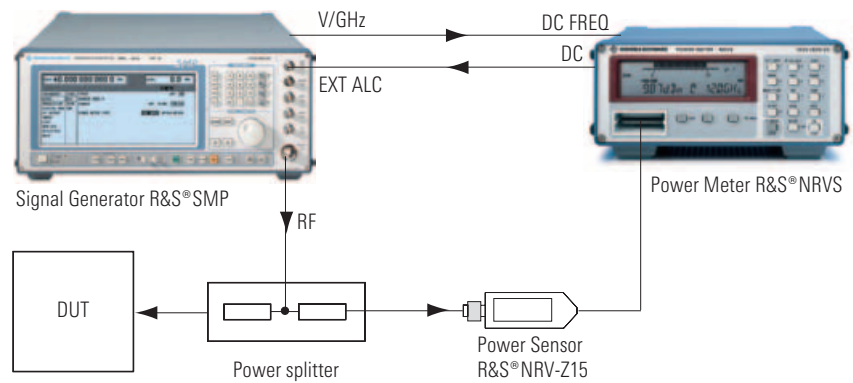

FIG 7: External level control for the Microwave Signal Generator R&S®SMP

### Scalar network analysis

The Microwave Signal Generator R&S®SMP used as a tracking generator in conjunction with the Spectrum Analyzer R&S®FSP and the option R&S®FSP-B10 provides a unique scalar network analysis function. This application features an extremely wide dynamic range, which allows, for example, filter resonances in the stop band to be displayed at very low levels.

Due to the user-definable frequency offset, measurements on frequency-converting devices can also be performed with this configuration.

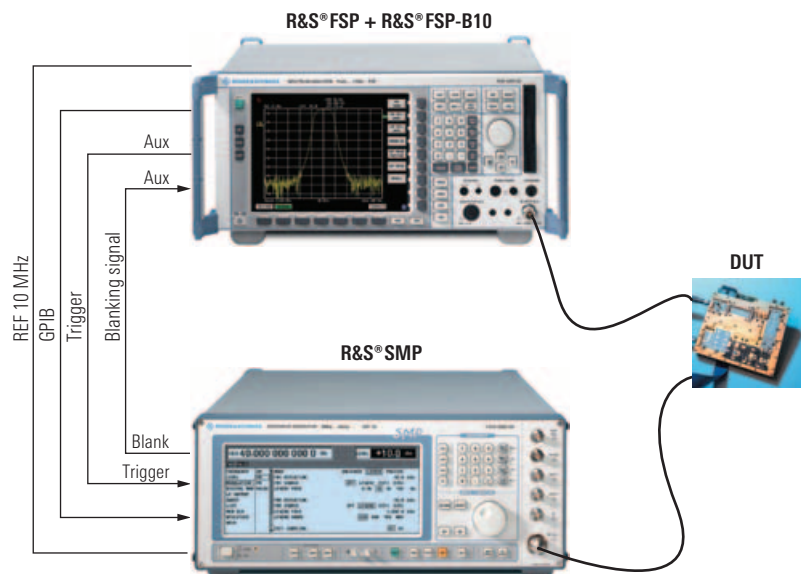
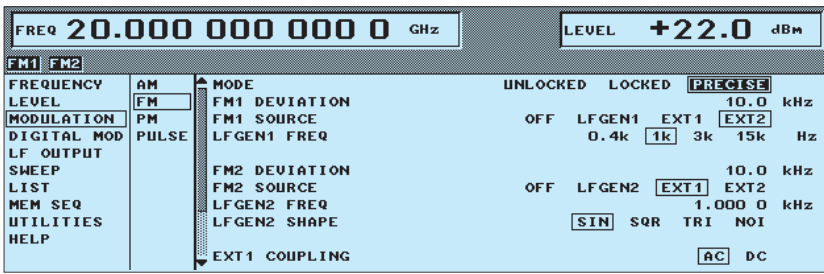

FIG 8: Scalar network analysis with the Microwave Signal Generator R&S®SMP and the Spectrum Analyzer R&S®FSP with option R&S®FSP-B10



The FM modulation menu shows the clear-cut representation of selectable parameters and current instrument status. Each setting can be made quickly and easily by means of the spinwheel and a few keys.

### Automatic measurement functions for production and test labs

The memory sequence is an extremely useful function. It provides convenient execution of standard test routines or frequently required sequences of different types of single measurements.

Up to 50 complete instrument setups can be stored. After programming the sequence of measurements to be executed, the user can activate the autorun control facility.

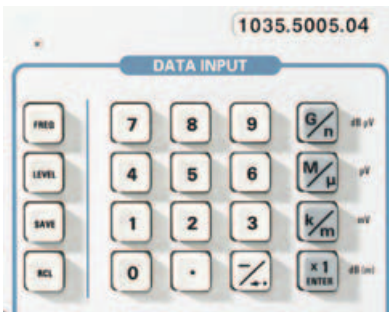

FIG 9: SAVE and RCL for storing and recalling settings

This function also allows synchronous operation with other units through triggering. Step times can be separately programmed for each step.

### Remote control to SCPI standard

The IEC/IEEE-bus remote control commands are in line with the SCPI guidelines. One of the advantages is that the user can exchange measuring instruments in an automatic system without having to modify the control software.

### Intelligent operating concept

#### Easy-to-follow menus

Neither multifunction keys nor obscure special functions burden the user. All functions are clearly arranged in menus. Menus and functions as well as parameter settings can be conveniently selected with a spinwheel.

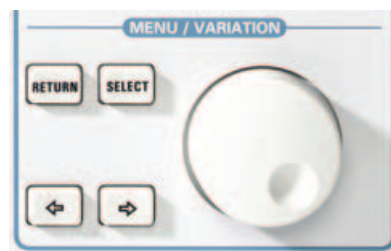

FIG 10: General settings and menu selection with spinwheel, RETURN, SELECT and arrow keys

### Menu memories

Frequently used menu settings can be stored in two memories and recalled at a keystroke.



FIG 11: Storage of menu settings

### Easy-to-read screen display

All settings associated with a certain function can be seen at a glance on the large-size, high-contrast LC display.

### HELP function

Explanatory remarks can be called up for each individual menu. This does away with wasting time in looking up functions in a manual.



FIG 12: Online help

## Expertise in microwaves

### Continuity of progress at Rohde & Schwarz

The name of Rohde & Schwarz is also synonymous with quality in the field of microelectronics.

Large investments have been made in advanced technologies to fully keep up with the ever increasing demands made on the precision and reliability of microwave modules. Rohde & Schwarz uses ultra-modern clean rooms and systems for the development and production of thin-film circuits.

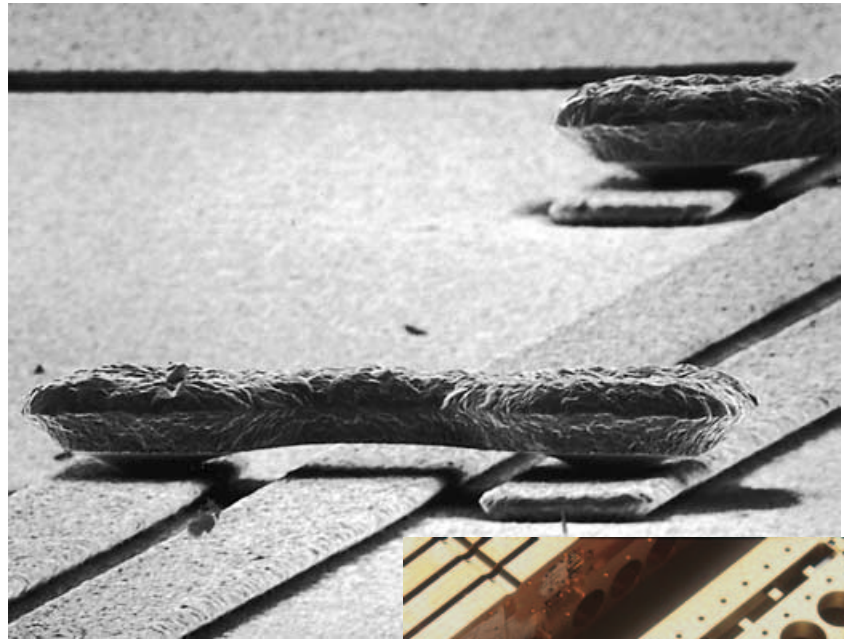

*Airbridges is an ideal technique for implementing PCB crossovers with excellent high-frequency characteristics. The photo above has been taken with a scanning electron microscope and shows such an airbridge which is only 0.05 mm long.*

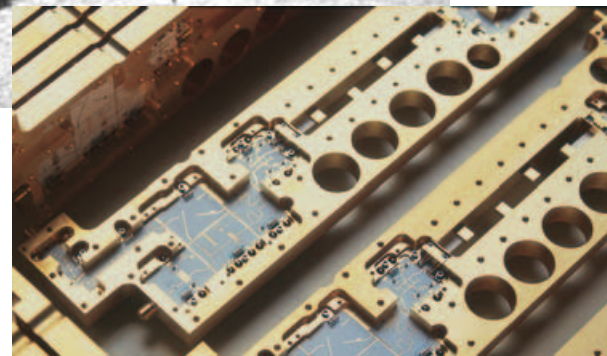



# Specifications

## Frequency

Range (standard) R&S®SMP02/R&S®SMP22 R&S®SMP03 R&S®SMP04	2 GHz to 20 GHz 2 GHz to 27 GHz 2 GHz to 40 GHz
Range (with option R&S®SMP-B11) R&S®SMP02/R&S®SMP22 R&S®SMP03 R&S®SMP04	10 MHz to 20 GHz 10 MHz to 27 GHz 10 MHz to 40 GHz
Resolution	0.1 Hz
Setting time (to within $<1 \times 10^{-6}$ ) after IEC/IEEE-bus delimiter	$<(11 \text{ ms} + 5 \text{ ms/GHz})^1$
Phase offset	adjustable in 1° steps
<b>Reference frequency</b>	<b>Standard      Option R&amp;S®SMP-B1</b>
Aging (after 30 days of operation)	$1 \times 10^{-6}$ /year $<1 \times 10^{-7}$ /year
Temperature effect (0°C to 55°C)	$2 \times 10^{-6}$ $<1 \times 10^{-10}/^\circ\text{C}$
Warm-up time	–      10 min
Output for internal reference Frequency Level $V_{\text{rms}}$ (EMF, sinewave) Source impedance	10 MHz 1 V 50 Ω
Input for internal reference Frequency Permissible frequency drift Input level ( $V_{\text{rms}}$ ) Input impedance	1 MHz to 16 MHz in 1 MHz steps $3 \times 10^{-6}$ 0.1 V to 2 V 200 Ω

## Spectral purity

Spurious signals	R&S®SMP02	R&S®SMP22	R&S®SMP03	R&S®SMP04
Harmonics <sup>2)</sup> f < 1.8 GHz	<-30 dBc (<+8 dBm)	<-25 dBc (<+8 dBm)	<-30 dBc (<+3 dBm)	<-30 dBc (<+0 dBm)
f ≥ 1.8 GHz	<-40 dBc (<+10 dBm)	<-25 dBc (<+15 dBm)	<-40 dBc (<+3 dBm)	<-40 dBc (<+0 dBm)
Harmonics <sup>2)</sup> (with options R&S®SMP-B12/-B13, pulse modulation on)				
f < 1.8 GHz	<-25 dBc (<+8 dBm)	<-25 dBc (<+8 dBm)	<-25 dBc (<+3 dBm)	<-25 dBc (<+0 dBm)
f ≥ 1.8 GHz	<-25 dBc (<+11 dBm)	<-25 dBc (<+11 dBm)	<-25 dBc (<+3 dBm)	<-25 dBc (<+0 dBm)
Subharmonics f ≤ 20 GHz f > 20 GHz	– –	– –	– <-40 dBc	– <-30 dBc
Nonharmonics at >10 kHz from carrier				
f < 2 GHz	typ. <-60 dBc	typ. <-60 dBc	typ. <-60 dBc	typ. <-60 dBc
2 to 20 GHz	<-60 dBc	<-60 dBc	<-60 dBc	<-60 dBc
f > 20 GHz	–	–	<-54 dBc	<-54 dBc

## SSB phase noise, 1 Hz bandwidth, FM off

Frequency range	Offset from carrier			
	100 Hz	1 kHz	10 kHz	100 kHz
10 MHz to <2 GHz <sup>3)</sup>	<-64 dBc	<-93 dBc	<-104 dBc	<-104 dBc
2 GHz to 10 GHz	<-64 dBc	<-93 dBc	<-105 dBc	<-105 dBc
>10 GHz to 20 GHz	<-58 dBc	<-87 dBc	<-99 dBc	<-99 dBc
>20 GHz to 27/40 GHz	<-54 dBc	<-81 dBc	<-93 dBc	<-93 dBc

## Residual FM, rms, FM off

Frequency range	Weighting bandwidth	
	300 Hz to 3 kHz	30 Hz to 20 kHz
10 MHz to <2 GHz <sup>3)</sup>	<5 Hz	<50 Hz
2 GHz to 10 GHz	<5 Hz	<50 Hz
>10 GHz to 20 GHz	<10 Hz	<75 Hz
>20 GHz to 27/40 GHz	<20 Hz	<150 Hz

## Residual AM, rms, AM off<sup>4)</sup>

Frequency range	Weighting bandwidth	
	300 Hz to 3 kHz	30 Hz to 20 kHz
10 MHz to <2 GHz	<0.1%	<0.2%
2 GHz to 20/27/40 GHz	<0.05%	<0.1%

## Level

### Maximum level<sup>4)</sup> R&S®SMP02/22 (without options R&S®SMP-B12/-B13)

Frequency range	R&S®SMP02		R&S®SMP22	
	Standard	With option R&S®SMP-B15	Standard	With option R&S®SMP-B15
10 MHz to <2 GHz	>+17 dBm			
2 GHz to 20 GHz	>+11.5 dBm	>+10 dBm	>+20 dBm	>+18.5 dBm

### Maximum level<sup>4)</sup> R&S®SMP02/22 (with options R&S®SMP-B12/-B13)

Frequency range	R&S®SMP02		R&S®SMP22	
	Pulse modulation off	Pulse modulation on	Pulse modulation off	Pulse modulation on
10 MHz to <2 GHz	>+13 dBm			
2 GHz to 20 GHz	same as max. level without options R&S®SMP-B12/-B13	>+13 dBm	same as max. level without options R&S®SMP-B12/-B13	>+13 dBm

### Maximum level<sup>4)</sup> R&S®SMP03/04 (without options R&S®SMP-B12/-B13)

Frequency range	R&S®SMP03		R&S®SMP04	
	Standard	With option R&S®SMP-B15	Standard	With option R&S®SMP-B17
10 MHz to <2 GHz	>+12 dBm			
2 GHz to <18 GHz	>+10 dBm	>+8.5 dBm	>+10 dBm	>+8.5 dBm
18 GHz to 20 GHz	>+6 dBm	>+4.5 dBm	>+6 dBm	>+4.5 dBm
>20 to 27/33 GHz	>+13 dBm	>+11 dBm	>+12 dBm	>+10 dBm
>33 GHz to 40 GHz	–	–	>+10 dBm	>+8 dBm

**Maximum level<sup>4)</sup> R&S®SMP03/SMP04 (with options R&S®SMP-B12/-B13)**

Frequency range	R&S®SMP03		R&S®SMP04	
	Pulse modulation off	Pulse modulation on	Pulse modulation off	Pulse modulation on
10 MHz to <2 GHz	>+10 dBm			
2 to 20/27/40 GHz	same as max. level without options R&S®SMP-B12/-B13			
Minimum level of all models	Without option R&S®SMP-B15/-B17 With option R&S®SMP-B15/-B17			
	-20 dBm -130 dBm			
Resolution	0.1 dB or 0.01 dB			

**Total accuracy<sup>3)5)</sup> (frequency response and temperature effect included)**

Frequency range	Level	Accuracy
10 MHz to <2 GHz	>+10 dBm	<±1.2 dB
	>-10 dBm	<±0.6 dB
	>-60 dBm	<±0.9 dB
	≤-60 dBm	<±1.4 dB
2 GHz to 20 GHz	>+10 dBm	<±1.3 dB
	>-10 dBm	<±0.7 dB
	>-60 dBm	<±1.0 dB
	≤-60 dBm	<±1.5 dB
>20 GHz to 27/40 GHz	>+10 dBm	<±1.5 dB
	>-10 dBm	<±0.9 dB
	>-60 dBm	<±1.2 dB
	≤-60 dBm	<±1.7 dB
Output impedance	50 Ω	
VSWR		
f ≤20 GHz	<2, typ. <1.6	
f >20 GHz	<2.2, typ. <1.8	
Setting time (after IEC/IEEE-bus delimiter)	<10 ms	
With option R&S®SMP-B15/-B17, with switching in attenuator set	<25 ms	
Non-interrupting level setting (ATTENUATOR MODE FIXED) Setting range	0 dB to 20 dB	

**Simultaneous modulation** any combination of AM (scan modulation), FM (ϕM) and pulse modulation

**Linear amplitude modulation**

Operating modes	internal, external AC/DC
Modulation depth <sup>6)</sup>	0% to 90%
Resolution	0.1%
Setting accuracy at AF = 1 kHz (m <80%) <sup>7)</sup>	<(4% of reading ±1%)
AM distortion at AF = 1 kHz (m = 60%) <sup>7)</sup> , f >50 MHz	<1%, typ. <0.5%
Modulation frequency range for frequency response <1 dB, m = 60%	DC to 100 kHz
f <2 GHz	DC to 10 kHz
f ≥2 GHz	DC to 50 kHz
Modulation input EXT1	
Input impedance	600 Ω or 100 kΩ
Input voltage (peak value) for selected modulation depth	1 V (HIGH/LOW warning if variation >3%)

**Logarithmic amplitude modulation (scan modulation)**

Operating modes	internal, external
Dynamic range	>30 dB
Sensitivity	0.1 dB/V to 10 dB/V
Resolution	0.01 dB/V
Rise/fall time (10%/90%)	<10 μs
Modulation input EXT1	
Input impedance	600 Ω or 100 kΩ
Input voltage	-6 V to +6 V

**Frequency modulation**

Operating modes	internal, external AC/DC, locked/unlocked, two-tone with two separate channels FM1 and FM2
Standard FM (without option R&S®SM-B5)	
Maximum deviation	
f ≤20 GHz	10 MHz
f >20 GHz	20 MHz
Resolution	
f ≤20 GHz	<1%, min. 10 Hz
f >20 GHz	<1%, min. 20 Hz
Setting accuracy at AF = 100 kHz and 500 kHz deviation	<10% of reading
FM distortion at AF = 50 kHz and 500 kHz deviation	<0.5%, typ. 0.05%
Modulation frequency range	
Locked mode	10 kHz to 5 MHz
Unlocked mode	DC to 5 MHz
Modulation frequency response	
Locked mode, modulation index <10, deviation = 100 kHz	
10 kHz to 5 MHz	<5 dB
Unlocked mode, deviation = 10 MHz	
10 Hz (DC) to 100 kHz	<1 dB
100 kHz to 5 MHz	<5 dB
Incidental AF = 50 kHz and 100 kHz deviation	<0.5%
Carrier frequency offset with FM	
Locked mode	-
Unlocked mode	
f ≤20 GHz	typ. <10 MHz
f >20 GHz	typ. <20 MHz
FM (with option R&S®SM-B5 <sup>8)</sup> )	
Maximum deviation	
f ≤20 GHz	1 MHz
f >20 GHz	2 MHz
Resolution	
f ≤20 GHz	<1%, min. 10 Hz
f >20 GHz	<1%, min. 20 Hz
Setting accuracy at AF = 1 kHz and deviation >1 kHz	<2% of reading
FM distortion at AF = 1 kHz and 500 kHz deviation	<0.5%, typ. 0.05%
Modulation frequency range	DC to 1 MHz
Modulation frequency response	
10 Hz (DC) to 50 kHz	<0.5 dB
50 kHz to 1 MHz	<4 dB
Incidental AF = 1 kHz and 40 kHz deviation	<0.5%
Carrier frequency offset with FM	
f ≤20 GHz	<100 Hz + 1% of deviation
f >20 GHz	<200 Hz + 1% of deviation
Carrier frequency drift with FM DC	typ. 0.005% of deviation per 1°C
Modulation inputs EXT1, EXT2	
Input impedance	600 Ω or 100 kΩ
Input voltage (peak value) for selected deviation	1 V (HIGH/LOW warning if variation >3%)

## Phase modulation with option R&S®SM-B5

Operating modes	internal, external AC/DC, two-tone with two separate channels $\phi M1$ and $\phi M2$
Maximum deviation $f \leq 20$ GHz $f > 20$ GHz	10 rad 20 rad
Resolution $f \leq 20$ GHz $f > 20$ GHz	<1%, min. 0.001 rad <1%, min. 0.002 rad
Setting accuracy at AF = 1 kHz $f \leq 20$ GHz $f > 20$ GHz	<(3% of reading + 0.01 rad) <(3% of reading + 0.02 rad)
$\phi M$ distortion at AF = 1 kHz and 5 rad deviation	<1%
Modulation frequency range	DC to 100 kHz
Modulation frequency response 10 Hz (DC) to 100 kHz	<3 dB
Modulation inputs EXT1, EXT2 Input impedance Input voltage (peak value) for selected deviation	600 $\Omega$ or 100 k $\Omega$ 1 V (HIGH/LOW warning if variation >3%)

## ASK modulation

Operating mode	external
Maximum modulation depth <sup>6)</sup>	90%
Resolution	0.1%
Data rate <sup>7)</sup>	0 Hz to 200 kHz
Rise/fall time (10%/90%)	<10 $\mu$ s
Modulation input EXT1 Input impedance Input level	600 $\Omega$ or 100 k $\Omega$ TTL/HCT signal, selectable polarity

## FSK modulation

Operating mode	external
Maximum shift Standard FM $f \leq 20$ GHz $f > 20$ GHz With option R&S®SM-B5 $f \leq 20$ GHz $f > 20$ GHz	10 MHz 20 MHz 1 MHz 2 MHz
Resolution $f \leq 20$ GHz $f > 20$ GHz	<1%, min. 10 Hz <1%, min. 20 Hz
Data rate Standard FM Locked mode Unlocked mode With option R&S®SM-B5	20 kHz to 2 MHz 0 Hz to 2 MHz 0 Hz to 2 MHz
Modulation input EXT1 Input impedance Input level	600 $\Omega$ or 100 k $\Omega$ TTL/HCT signal, selectable polarity

## Pulse modulation

Operating modes	external, internal with option R&S®SMP-B14
Standard (without options R&S®SMP-B12/-B13) Frequency range On/off ratio Rise/fall time (10%/90%) Minimum pulse width Maximum pulse pause With level control switched on (ALC ON)  With level control switched off (ALC OFF) Minimum pulse/pause ratio With level control switched on (ALC ON)  With level control switched off (ALC OFF) Pulse repetition frequency Pulse delay Video feedthrough	$\geq 2$ GHz >50 dB (level >0 dBm) <500 ns 1 $\mu$ s  any (R&S®SMP02/22)/ 40 ms (R&S®SMP03/04)  any  any (R&S®SMP02/22)/ 1:100 (R&S®SMP03/04)  any 0 Hz to 500 kHz typ. 100 ns <15 mV (peak value)
With options R&S®SMP-B12/-B13 Frequency range With option R&S®SMP-B13 With option R&S®SMP-B12 On/off ratio Rise/fall time (10%/90%) Minimum pulse width With level control switched on (ALC ON)  With level control switched off (ALC OFF) Maximum pulse pause With level control switched on (ALC ON)  With level control switched off (ALC OFF) Minimum pulse/pause ratio With level control switched on (ALC ON)  with level control switched off (ALC OFF) Pulse repetition frequency Pulse delay Video feedthrough PULSE modulation input Input level Input impedance	10 MHz to <2 GHz $\geq 2$ GHz >80 dB <10 ns  20 ns (R&S®SMP02/22)/ 1 $\mu$ s (SMP03/04)  20 ns  any (R&S®SMP02/22)/ 40 ms (R&S®SMP03/04)  any  any (R&S®SMP02/22)/ 1:100 (R&S®SMP03/04)  any 0 Hz to 10 MHz typ. 50 ns <15 mV (peak value)  TTL (HCT) 50 $\Omega$ or 10 k $\Omega$

## Internal modulation generator

Frequency	0.4/1/3/15 kHz $\pm$ 3%
Open-circuit voltage at LF connector	1 V $\pm$ 1% ( $R_{out} = 10 \Omega$ , $R_{load} > 200 \Omega$ ) (peak value)

### LF generator option R&S®SM-B2

Waveforms	sinewave, triangular, squarewave, noise
Frequency range Sinewave, noise Triangular, squarewave	0.1 Hz to 500 kHz 0.1 Hz to 50 kHz
Resolution	0.1 Hz
Frequency accuracy	$<1 \times 10^{-4}$
Frequency response (sinewave) Up to 100 kHz Up to 500 kHz	$<0.3$ dB $<0.5$ dB
Distortion (20 Hz to 100 kHz)	$<0.1\%$ (for level $>0.5$ V)
Open-circuit voltage at LF connector Resolution Setting accuracy at 1 kHz	1 mV to 4 V ( $R_{out} = 10 \Omega$ , $R_{load} > 200 \Omega$ ) 1 mV $\pm 1\% + 1$ mV
Frequency setting time (after IEC/IEEE-bus delimiter)	$<10$ ms

### Pulse generator option R&S®SMP-B14

Operating modes	single pulse, delayed pulse, double pulse
Active trigger edge	positive or negative
Pulse repetition period Resolution Accuracy	100 ns to 85 s 5 digits, min. 20 ns same as reference frequency
Pulse width Resolution Accuracy	40 ns to 1 s 4 digits, min. 20 ns $<(5\%$ of reading $\pm 3$ ns)
Pulse delay Resolution Accuracy	40 ns to 1 s 4 digits, min. 20 ns $\pm 5\%$ of reading $-10$ ns to $+20$ ns
Double pulse Resolution Accuracy	60 ns to 1 s 4 digits, min. 20 ns $\pm 5\%$ of reading $-10$ ns to $+20$ ns
Trigger delay	$<50$ ns
PULSE modulation input Input level Input impedance	TTL (HCT) $50 \Omega$ or $10 \text{ k}\Omega$
SYNC output	TTL level (HC), 40 ns pulse width
VIDEO output	TTL level (HC)

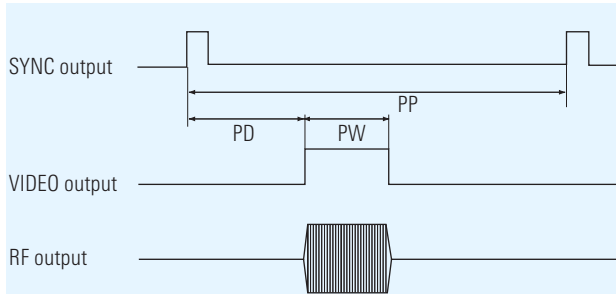

**The pulse generator option enables the pulse delay PD, pulse width PW and pulse repetition period PP to be set with high accuracy and resolution.**

### RF control output

Frequency range	2 GHz to 20 GHz
Level	approx. 0 dBm

### Sweep

	digital sweep in discrete steps
RF sweep, AF sweep Operating modes	AF sweep with option R&S®SM-B2 automatic, single-shot, manual or externally triggered, linear or logarithmic
Sweep range Linear step width Logarithmic step width	user-selectable 0.01% to 50%
Level sweep Operating modes	automatic, single-shot, manual or externally triggered, logarithmic
Sweep range Step width	0.1 dB to 20 dB 0.1 dB to 20 dB
Step time Resolution	10 ms to 1 s 0.1 ms
Markers	3, user-selectable
MARKER output	TTL/HC logic signal, selectable polarity
X output	0 V to 10 V
BLANK output	TTL/HC logic signal, selectable polarity
TRIGGER input	TTL/HCT logic signal, polarity of active trigger edge selectable
STOP input	TTL/HCT logic signal, selectable polarity

### LIST mode

	frequency and level values can be stored and read out fast; permissible level variation range: 20 dB
Operating modes	automatic, single-shot, manual or externally triggered
Max. length of list	2003 pairs of frequency and level values
Step time Resolution	(1 ms to 1 s) + the lesser of 5 ms/GHz or 50 ms 0.1 ms

### Memory for instrument settings

Storable settings	50
Memory sequence modes Operating modes	automatic, single-shot, manual or externally triggered
Step time Resolution	50 ms to 60 s 1 ms



### Auxiliary interface with option R&S®SMP-B18

V/GHz output	output voltage proportional to frequency, 0.5 V/GHz <sup>9)</sup> or 1 V/GHz selectable
Z output	user-selectable level range –10 V to +10 V

### Remote control

System	IEC 625 (IEEE488)
Command set	SCPI 1992.0
Connector	24-contact Amphenol
IEC/IEEE-bus address	0 to 30
Interface functions	SH1, AH1, T6, L4, SR1, RL1, PP1, DC1, DT1, CO

### General data

<b>Power supply</b>	90 V to 132 V (AC), 47 Hz to 440 Hz 180 V to 265 V (AC), 47 Hz to 440 Hz autoranging, max. 400 VA safety class I to VDE 0411 (IEC 348)
<b>Electromagnetic compatibility</b>	
Standards adhered to	postal regulation 243/1991 EN55011 (VDE 0875 T11), class B VDE 0875, suppression level K MIL-STD-461B – RE02 radiated emissions – CE03 conducted emissions – CS01/02 conducted susceptibility
RF leakage (f < 1 GHz)	<0.1 µV (induced in a two-turn coil 2.5 cm in diameter held 2.5 cm away from the surface of the case)
Radiated susceptibility	3 V/m

<b>Ambient conditions</b>	
Operating temperature range	0°C to 55°C <sup>10)</sup>
Storage temperature range	–40°C to +70°C
Humidity	DIN IEC 68-2-30, +40°C
<b>Mechanical stress</b>	
Shock	to MIL-STD-810D, 40 g shock spectrum
Vibration Sinusoidal Random	to DIN IEC 68-2-6, 5 Hz to 55 Hz 10 m/s <sup>2</sup> rms, 10 Hz to 300 Hz
<b>Dimensions (W × H × D)</b>	435 mm × 192 mm × 570 mm
<b>Weight</b>	27 kg, when fully equipped

- <sup>1)</sup> For frequency changes beyond the 2 GHz and 20 GHz frequency limit the setting time is max. 50 ms longer.
- <sup>2)</sup> Specifications for harmonics above 20 GHz (R&S®SMP 02/R&S®SMP 22), 27 GHz (R&S®SMP 03) and 40 GHz (R&S®SMP 04) only typical.
- <sup>3)</sup> Without optional Attenuator R&S®SMP-B15/-B17 specifications apply to levels >–5 dBm only.
- <sup>4)</sup> The maximum level is reduced by up to 2 dB in the temperature range 35°C to 55°C.
- <sup>5)</sup> The specified accuracy only applies to temperatures from 15°C to 35°C. Outside this range the accuracy may be degraded by max. 0.7 dB.
- <sup>6)</sup> The modulation depth adjustable within the AM specifications continuously decreases from 6 dB below the maximum level up to the maximum level.
- <sup>7)</sup> This specification does not apply to
  - a) non-interrupting level setting (ATTENUATOR MODE FIXED) if option R&S®SMP-B15/-B17 is used,
  - b) levels below –5 dBm without option R&S®SMP-B15/-B17,
  - c) external level control mode (EXT ALC).
- <sup>8)</sup> The functions of the standard FM remain available.
- <sup>9)</sup> Above 20 GHz (R&S®SMP 03/04) only 0.5 V/GHz available.
- <sup>10)</sup> The contrast of the LC display is degraded at high temperatures.



## Ordering information

Order designation	Type	Order No.
Microwave Signal Generator	R&S®SMP02	1035.5005.02
Microwave Signal Generator	R&S®SMP22	1035.5005.22
Microwave Signal Generator	R&S®SMP03	1035.5005.03
Microwave Signal Generator	R&S®SMP04	1035.5005.04
<b>Accessories supplied</b>	power cable, operating manual	
For R&S®SMP02/22/03 For R&S®SMP04	female adapter 3.5 mm female adapter 2.9 mm	
<b>Options</b>		
OCXO Reference Oscillator	R&S®SMP-B1	1036.5109.02
Frequency Extension 0.01 GHz to 2 GHz <sup>1)</sup>	R&S®SMP-B11	1036.6240.02
Pulse Modulator 2 GHz to 20 GHz (R&S®SMP02, R&S®SMP22) <sup>1)</sup>	R&S®SMP-B12	1036.5750.02
2 GHz to 27 GHz (R&S®SMP03) <sup>1)</sup>	R&S®SMP-B12	1036.5750.03
2 GHz to 40 GHz (R&S®SMP04) <sup>1)</sup>	R&S®SMP-B12	1036.5750.04
0.01 GHz to 2 GHz <sup>1)</sup>	R&S®SMP-B13	1036.7147.02
Pulse Generator	R&S®SMP-B14	1036.7347.02
RF Attenuator 27 GHz (R&S®SMP02, R&S®SMP22, R&S®SMP03) <sup>1)</sup> 40 GHz (R&S®SMP04) <sup>1)</sup>	R&S®SMP-B15 R&S®SMP-B17	1036.5250.02 1036.5550.02
Auxiliary Interface	R&S®SMP-B18	1036.8920.02
Rear Connectors for RF, AF R&S®SMP02, R&S®SMP22, R&S®SMP03 <sup>1)</sup> R&S®SMP04 <sup>1)</sup>	R&S®SMP-B19 R&S®SMP-B20	1039.4303.02 1039.4503.02
LF Generator	R&S®SM-B2	1036.7947.02
FM/φM Modulator	R&S®SM-B5	1036.8489.02
19" Rack Adapter	R&S®ZZA-94	0396.4905.00

Order designation	Type	Order No.
<b>Extras</b>		
Service Kit	R&S®SM-Z3	1085.2500.02
Trolley	R&S®ZZK-1	1014.0510.00
Transit Case	R&S®ZZK-945	1013.9372.00
Adapter (R&S®SMP02, R&S®SMP22, R&S®SMP03) 3.5 mm, female 3.5 mm, male N, female N, male		1021.0512.00 1021.0529.00 1021.0535.00 1021.0541.00
Adapter (R&S®SMP04) 2.9 mm, female 2.9 mm, male N, female N, male		1036.4790.00 1036.4802.00 1036.4777.00 1036.4783.00

<sup>1)</sup> Factory-fitted option.



[www.rohde-schwarz.com](http://www.rohde-schwarz.com)

R&S® is a registered trademark of Rohde & Schwarz GmbH & Co. KG · Trade names are trademarks of the owners · Printed in Germany (Bi sk/edok)  
0758.0951.32 · Microwave Signal Generator R&S®SMP · Version 04.00 · December 2003 · Data without tolerance limits is not binding · Subject to change